



EMC Data Sheet

Unidrive-M

Model size 3

Variable Speed AC drive for
induction and permanent magnet
motors

Unidrive-M Model size 3 EMC Data Sheet

Safety Warnings



A Warning contains information which is essential for avoiding a safety hazard.



A Caution contains information which is necessary for avoiding a risk of damage to the product or other equipment.

NOTE:

A Note contains information which helps to ensure correct operation of the product.

Installation and Use

The information given in this data sheet is derived from tests and calculations on sample products. It is provided to assist in the correct application of the product, and is believed to correctly reflect the behaviour of the product when operated in accordance with the instructions. The provision of this data does not form part of any contract or undertaking. Where a statement of conformity is made with a specific standard, the manufacturer takes all reasonable measures to ensure that its products are in conformance. Where specific values are given these are subject to normal engineering variations between samples of the same product. They may also be affected by the operating environment and details of the installation arrangement.

The manufacturer accepts no liability for any consequences resulting from inappropriate, negligent or incorrect installation of the equipment.

The contents of this data sheet are believed to be correct at the time of printing. The manufacturer reserves the right to change the specification of the product or its performance, or the contents of the data sheet, without notice.



All electrical installation and maintenance work must be carried out by qualified electricians, familiar with the requirements for safety and EMC. The installer is responsible for ensuring that the end product or system complies with all relevant laws in the country where it is used.

Copyright

All rights reserved. No parts of this data sheet may be reproduced or transmitted in any form by any means, electrical or mechanical including photocopying, recording or by an information storage or retrieval system, without permission in writing from the publisher

Copyright © 16 March 2015 Control Techniques Ltd

Unidrive-M Model size 3 EMC Data Sheet

Contents

1. Products.....	4
2. Immunity	4
3. Emission	7
3.1 Supply Harmonics.....	7
3.2 Conducted Radio Frequency Emission	12
3.3 Radiated Emission.....	17
4. Installation and Wiring Guidelines	20

Unidrive-M Model size 3 EMC Data Sheet

1. Products

This data sheet applies to the following products:

Mxxx - 032 00050A, Mxxx - 032 00066A, Mxxx - 032 00080A, Mxxx - 032 00106A,
Mxxx - 034 00025A, Mxxx - 034 00031A, Mxxx - 034 00045A, Mxxx - 034 00062A,
Mxxx - 034 00078A, Mxxx - 034 00100A

F300-03200066, F300-03200080, F300-03200110, F300-03200127
F300-03400034, F300-03400045, F300-03400062, F300-03400077,
F300-03400104, F300-03400123

H300-03200066, H300-03200080, H300-03200110, H300-03200127
H300-03400034, H300-03400045, H300-03400062, H300-03400077,
H300-03400104, H300-03400123

Where Mxxx denotes M600, M700, M701 or M702;

H300 is the drive for HVAS applications and F300 is for flow applications. Both H300 and F300 are as the same as the M600 but slightly different in the firmware so the power stages are the same. However, H300 and F300 only operate in the normal duty mode.

2. Immunity

2.1.1 Compliance

The drives comply with the following international and European harmonised standards for immunity:

Table 1 Immunity test levels

Standard	Type of immunity	Test specification	Application	Level
EN 61000-4-2 IEC 61000-4-2	Electrostatic discharge	6 kV contact discharge 8 kV air discharge	Module enclosure	Level 3 (industrial)
EN 61000-4-3 IEC 61000-4-3	Radio frequency radiated field	Prior to modulation: 10 V/m 80 - 1000 MHz 3 V/m 1.4 - 2.0 GHz 1 V/m 2.0 - 2.7 GHz 80% AM (1 kHz) modulation Safe Torque Off (STO) tested to : 20V/m 80 - 1000MHz 6V/m 1.4 - 2.0 GHz 3V/m 2.0 - 2.7 GHz	Module enclosure	Level 3 (industrial)
EN 61000-4-4 IEC 61000-4-4	Fast transient burst	5/50 ns 2 kV transient at 5 kHz repetition frequency via coupling clamp	Control lines	Level 4 (industrial harsh)
		5/50 ns, 2 kV transient at 5 kHz repetition frequency by direct injection	Power lines	Level 3 (industrial)
IEC 61000-4-5	Surges	Common mode 4 kV 1.2/50µs wave shape	AC supply lines: line to earth	Level 4

Unidrive-M Model size 3 EMC Data Sheet

Standard	Type of immunity	Test specification	Application	Level
		Differential mode 2 kV	AC supply lines: line to line	Level 3
		Common mode 1 kV	Control lines	(Note:1)
EN 61000-4-6 IEC 61000-4-6	Conducted radio frequency	10 V prior to modulation 0.15 - 80 MHz 80% AM (1 kHz) modulation	Control and power lines	Level 3 (industrial)
EN 61000-4-11 IEC 61000-4-11	Voltage dips, short interruptions & variations	All durations	AC supply lines	
EN 61000-4-8 IEC 61000-4-8	Power frequency magnetic field	1700 A/m RMS. 2400 A/m peak (2.1 mT RMS 3 mT peak) continuous at 50 Hz	Module enclosure	Exceeds level 5
EN 61000-6-1 IEC 61000-6-1	Generic immunity standard for the residential, commercial and light - industrial environment			Complies
EN 61000-6-2 IEC 61000-6-2	Generic immunity standard for the industrial environment			Complies
EN 61800-3 IEC 61800-3	Product standard for adjustable speed power drive systems (immunity requirements)		Meets immunity requirements for first and second environments	

Note: 1 Applies to ports where connections may exceed 30 m length. Special provisions may be required in some cases – see additional information below.

Unless stated otherwise, immunity is achieved without any additional measures such as filters or suppressors. To ensure correct operation the wiring guidelines specified in the User Guide must be followed. All inductive components such as relays, contactors, electromagnetic brakes must be fitted with appropriate suppression.

2.1.2 Surge immunity of control circuits

The input/output ports for the control circuits are designed for general use within machines and small systems without any special precautions.

These circuits meet the requirements of EN 61000-6-2 (1 kV surge) provided that the 0 V connection is not earthed. In general the circuits cannot withstand the surge directly between the control lines and the 0 V connection.

The surge test simulates the effect of a lightning strike, or a severe electrical fault, where high transient voltages may exist between different points in the grounding system. This is a particular risk where the circuits are routed outside a building, or if the grounding system in a building is not well bonded.

In applications where control circuits are exposed to high-energy voltage surges, some special measures are required to prevent malfunction or damage. In general, circuits that are routed outside the building where the drive is located, or are longer than 30 m need additional protection. One of the following techniques should be used:

1. Galvanic isolation, Do not connect the control 0 V terminal to ground. Avoid loops in the control wiring, i.e. ensure every control wire is routed next to its associated return (0 V) wire.

Unidrive-M Model size 3 EMC Data Sheet

2. Screened cable. The cable screen may be connected to ground at both ends. In addition the ground conductors at both ends of the cable must be bonded together by a power ground cable (equal potential bonding cable) with cross-sectional area of at least 10 mm². This ensures that in the event of a fault, the fault current flows through the ground cable and not through signal cable screen. If the building or plant has a well-designed common bonded network this precaution is not necessary.
3. Additional over-voltage suppression. This applies to analogue and digital inputs and outputs. A zener diode network or a commercially available surge suppressor may be connected between the signal line and 0 V as shown in Figures 1 and 2.

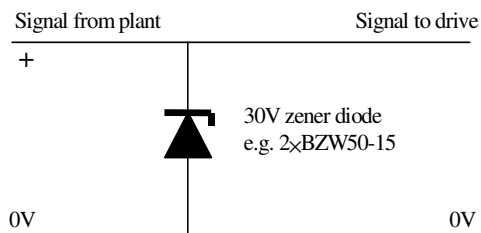

Figure 1 Surge suppression for digital and uni-polar analogue inputs and outputs

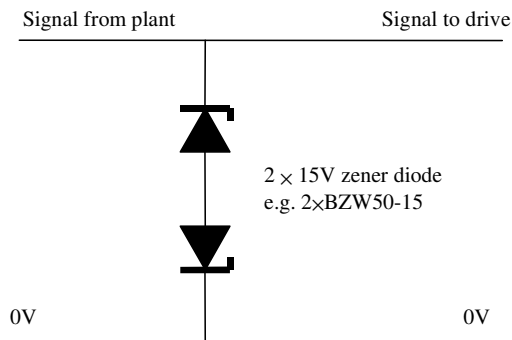

Figure 2 surge suppression for bipolar analogue inputs and outputs

Surge suppression devices are available as rail-mounting modules, e.g. from Phoenix Contact GmbH:

Unipolar	TT-UKK5-D/24 DC
Bipolar	TT-UKK5-D/24 AC

These devices are not suitable for encoder signals or fast digital data networks because the capacitance of the zener diodes adversely affects the signal. Most encoders have galvanic isolation of the signal circuit from the motor frame, in which case no precautions are required. For data networks, follow the specific recommendations for the particular network.

Unidrive-M Model size 3 EMC Data Sheet

3. Emission

3.1 *Supply Harmonics*

3.1.1 General

Emission occurs over a wide range of frequencies. The effects are divided into three main categories:

- Low frequency effects, such as supply harmonics and notching.
- High frequency emission below 30 MHz where emission is predominantly by conduction.
- High frequency emission above 30 MHz where emission is predominantly by radiation.

3.1.2 Supply voltage notching

The drives cause no significant notching of the supply voltage. This is because of the use of uncontrolled input rectifiers.

3.1.3 Supply harmonics

The input current contains harmonics of the supply frequency. The harmonic current levels are affected by the supply impedance (fault current level). The table shows the levels calculated with fault level of 18 kA at 200 V and 400V 50 Hz. This meets and exceeds the requirements of IEC 61800-3. For installations where the fault level is lower, so that the harmonic current is more critical, the upper limit for harmonic current will also be lower.

The calculations have been verified by laboratory measurements on sample drives.

Note that the RMS current in these tables is lower than the maximum specified in the installation guide, since the latter is a worst-case value provided for safety reasons which takes account of permitted supply voltage imbalance. The motor efficiency also affects the current. A standard IE2 4-pole motor has been assumed.

For balanced sinusoidal supplies, all even and triple harmonics are absent.

The supply voltages for the calculations are 230 V and 400 V at 50 Hz with the drives operating at their rated load current. The harmonic percentages do not change substantially for other voltages and frequencies within the drive specification.

Unidrive-M Model size 3 EMC Data Sheet

3.1.4 Harmonics without line reactor

The harmonic currents produced by the drives are shown in Table 2
 This table covers operation in both standard and heavy-duty modes (shown shaded).

Displacement Power Factor is defined as $\cos\Phi$ where Φ is the phase angle that the current is lagging behind the voltage.

Power factor is defined as:

$$PF = \frac{I_1}{I_{rms}} \cdot \cos\phi$$

Table 2 Harmonic Currents without Line Choke

Model No.	Motor Power (kW)	RMS Current (A)	Fund. Current (A)	THD (%)	PWHF (%)	Harmonic order, magnitude as % of fundamental															DPF $\cos\Phi$	Power Factor	
						5	7	11	13	17	19	23	25	29	31	35	37	41	43	47			49
Mxxx - 032 00050A	1.1	7.7	4.3	149.5	152.4	90.9	82.5	60.7	48.9	26.7	17.6	6.8	6.0	6.6	6.1	3.8	2.9	2.5	2.6	2.2	1.9	0.98	0.55
	0.75	6.8	3.7	152.6	167.4	91.4	83.4	62.6	51.0	29.1	19.9	7.8	6.1	6.7	6.5	4.5	3.4	2.5	2.6	2.5	2.2	0.99	0.55
Mxxx - 032 00066A	1.5	9.1	5.2	145.4	132.9	90.2	81.2	58.2	45.8	23.4	14.7	5.8	6.0	6.3	5.4	3.1	2.5	2.6	2.5	1.9	1.5	0.99	0.57
	1.1	8.7	4.9	146.5	138.2	90.4	81.6	58.9	46.7	24.3	15.4	6.0	6.0	6.4	5.6	3.3	2.6	2.6	2.6	2.0	1.6	0.99	0.56
Mxxx - 032 00080A	2.2	13.8	8.2	135.7	93.2	88.3	77.7	51.6	38.2	15.8	8.5	5.6	6.2	4.7	3.4	2.2	2.4	2.2	1.7	1.2	1.3	0.99	0.59
	1.5	10.4	6.0	142.3	119.6	89.7	80.2	56.2	43.5	21.0	12.6	5.5	6.1	5.9	4.8	2.6	2.4	2.6	2.4	1.6	1.3	0.99	0.57
Mxxx - 032 00106A	3	15.7	9.4	132.8	83.0	87.7	76.6	49.5	35.9	13.7	6.9	5.7	6.1	4.1	2.8	2.2	2.4	1.9	1.4	1.2	1.3	0.99	0.60
	2.2	13.3	7.9	136.4	96.1	88.5	78.0	52.1	38.9	16.4	8.9	5.6	6.2	4.9	3.6	2.2	2.4	2.2	1.8	1.3	1.3	0.99	0.59
Mxxx - 034 00025A	1.1	4.8	2.3	179.3	307.2	94.7	89.6	75.5	67.1	49.1	40.2	23.8	16.8	6.1	3.0	3.9	4.7	4.6	4.0	2.3	1.6	0.99	0.49
	0.75	3.6	1.7	185.1	344.0	95.2	90.5	77.6	69.8	52.8	44.2	28.1	20.9	9.5	5.5	3.4	4.4	5.1	4.8	3.4	2.6	0.99	0.47
Mxxx - 034 00031A	1.5	6.2	3.1	174.3	276.4	94.2	88.7	73.5	64.6	45.7	36.5	20.1	13.3	3.5	1.8	4.2	4.6	3.8	3.0	1.3	1.0	0.98	0.49
	1.1	4.4	2.1	181.1	318.4	94.8	89.9	76.2	67.9	50.3	41.4	25.1	18.1	7.1	3.6	3.8	4.7	4.9	4.4	2.7	1.9	0.99	0.48
Mxxx - 034 00045A	2.2	8.3	4.2	168.9	244.3	93.6	87.6	71.2	61.6	41.9	32.5	16.2	9.8	1.1	2.0	4.1	4.1	2.6	1.7	0.7	1.1	0.99	0.50
	1.5	6.2	3.1	174.3	276.4	94.2	88.7	73.5	64.6	45.7	36.5	20.1	13.3	3.5	1.8	4.2	4.6	3.8	3.0	1.3	1.0	0.98	0.49
Mxxx - 034 00062A	3	11.1	6.1	151.9	154.3	91.4	83.4	62.5	50.9	28.7	19.2	5.4	2.7	4.8	4.9	3.3	2.2	1.5	1.8	1.9	1.6	0.99	0.55
	2.2	9.1	4.9	155.7	174.4	92.0	84.4	64.6	53.4	31.7	22.1	7.6	3.7	4.7	5.2	4.1	3.0	1.6	1.7	2.1	1.9	0.99	0.54
Mxxx - 034 00078A	4	11.8	8.6	94.7	41.7	74.6	54.4	17.5	7.4	6.4	5.0	2.5	2.7	1.7	1.4	1.3	1.0	0.9	0.9	0.6	0.6	0.99	0.72
	3	9.1	6.5	100.2	47.1	77.0	58.3	22.0	10.2	6.7	6.1	2.8	2.7	2.3	1.7	1.5	1.4	0.9	1.0	0.8	0.7	0.98	0.70
Mxxx - 034 00100A	5.5	13.7	10.1	91.7	38.5	73.1	52.1	15.1	6.3	6.1	4.3	2.5	2.6	1.4	1.4	1.1	0.9	0.9	0.7	0.6	0.6	0.99	0.73
	4	11.4	8.3	95.4	42.4	74.9	54.9	18.1	7.8	6.5	5.1	2.5	2.7	1.8	1.4	1.3	1.1	0.9	0.9	0.6	0.6	0.99	0.72

Unidrive-M Model size 3 EMC Data Sheet

3.1.5 Harmonics with $\leq 2\%$ line reactor

The harmonic current levels can be reduced by fitting a reactor (choke) in series with the input supply lines to the drive.

Table 3 shows the harmonics when a reactor is fitted in series with the supply lines.

To avoid excessive voltage drop at full load, the inductance is calculated for a maximum volt drop of 2% of the mains voltage. The reactor must be rated to carry the RMS current shown in the table. The peak current rating of the reactor should be at least twice the RMS current rating in order to avoid magnetic saturation.

Table 3 Harmonic Currents with 2% Line Choke

Model No.	Motor Power (kW)	RMS current (A)	Fund. current (A)	THD (%)	PWHF (%)	Harmonic order, magnitude as % of fundamental																AC line choke nom (mH)	DPF Cos ϕ	Power Factor
						5	7	11	13	17	19	23	25	29	31	35	37	41	43	47	49			
Mxxx - 032 00050A	1.1	4.8	4.1	61.1	26.2	52.8	28.3	8.1	6.2	3.7	2.6	2.2	1.5	1.5	1.0	1.0	0.8	0.7	0.6	0.6	0.5	2.5	0.99	0.85
	0.75	4.4	3.6	66.5	27.2	56.8	32.3	8.2	7.1	3.7	3.0	2.2	1.6	1.5	1.1	1.0	0.8	0.8	0.6	0.6	0.5	2.5	0.99	0.83
Mxxx - 032 00066A	1.5	5.7	5.0	54.4	24.6	47.9	23.4	8.0	5.2	3.7	2.3	2.1	1.4	1.3	1.0	0.9	0.7	0.6	0.6	0.5	0.4	2.5	0.99	0.87
	1.1	5.5	4.8	56.1	25.0	49.1	24.6	8.1	5.4	3.7	2.3	2.1	1.4	1.4	1.0	0.9	0.7	0.7	0.6	0.5	0.4	2.5	0.99	0.86
Mxxx - 032 00080A	2.2	9.9	8.0	73.5	27.3	62.1	37.1	7.7	7.9	3.5	3.3	2.1	1.8	1.4	1.2	0.9	0.8	0.7	0.6	0.5	0.5	1.0	0.99	0.80
	1.5	7.5	5.9	81.0	34.7	67.0	43.1	9.8	7.9	5.0	3.4	2.9	2.1	1.8	1.5	1.1	1.1	0.8	0.8	0.6	0.6	1.0	0.99	0.77
Mxxx - 032 00106A	3	11.1	9.2	67.4	25.7	57.7	32.8	7.6	6.9	3.5	2.9	2.1	1.5	1.4	1.0	1.0	0.7	0.7	0.5	0.5	0.5	1.0	0.99	0.82
	2.2	9.6	7.7	74.4	28.1	62.8	37.8	7.9	7.9	3.7	3.3	2.2	1.8	1.4	1.2	1.0	0.9	0.7	0.7	0.5	0.5	1.0	0.99	0.79
Mxxx - 034 00025A	1.1	3.1	2.3	93.3	45.9	73.7	53.1	16.8	8.3	7.0	5.2	3.1	3.0	1.8	1.7	1.4	1.2	1.1	0.9	0.7	0.7	3.2	0.99	0.73
	0.75	2.4	1.7	99.8	52.7	76.7	57.9	21.9	10.9	7.6	6.5	3.3	3.2	2.5	1.9	1.7	1.5	1.1	1.1	0.8	0.7	3.2	0.99	0.71
Mxxx - 034 00031A	1.5	4.0	3.0	87.6	39.4	70.8	48.6	12.7	7.2	6.1	3.9	3.0	2.6	1.6	1.6	1.1	1.1	0.9	0.7	0.7	0.6	3.2	0.99	0.75
	1.1	2.9	2.1	95.3	48.0	74.6	54.6	18.2	8.9	7.3	5.6	3.1	3.1	2.0	1.7	1.5	1.3	1.1	1.0	0.7	0.7	3.2	0.99	0.72
Mxxx - 034 00045A	2.2	5.5	4.1	87.1	37.3	70.6	48.3	12.2	6.7	5.8	3.7	2.9	2.5	1.5	1.6	1.0	1.0	0.8	0.7	0.7	0.6	2.5	0.99	0.75
	1.5	4.1	3.0	93.5	44.6	73.8	53.3	16.8	8.0	6.9	5.1	3.0	3.0	1.8	1.6	1.4	1.1	1.0	0.9	0.7	0.7	2.5	0.99	0.73
Mxxx - 034 00062A	3	7.5	6.0	75.3	27.3	63.5	38.5	7.7	7.5	3.7	3.1	2.2	1.7	1.4	1.1	0.9	0.8	0.7	0.6	0.5	0.5	2.5	0.99	0.79
	2.2	6.2	4.8	80.1	32.2	66.5	42.4	9.1	7.5	4.6	3.2	2.7	1.9	1.7	1.4	1.1	1.0	0.8	0.8	0.5	0.5	2.5	0.99	0.77
Mxxx - 034 00078A	4	9.3	8.4	48.9	24.4	43.5	19.9	7.5	4.3	3.6	2.1	2.1	1.4	1.4	1.0	0.9	0.8	0.6	0.6	0.4	0.4	2.5	0.99	0.89
	3	7.3	6.3	57.9	25.8	50.2	26.6	7.6	5.5	3.7	2.4	2.2	1.5	1.5	1.0	1.0	0.8	0.8	0.6	0.5	0.5	2.5	0.99	0.86
Mxxx - 034 00100A	5.5	11.1	9.9	50.7	24.8	44.9	21.3	7.4	4.5	3.6	2.2	2.2	1.4	1.4	1.1	1.0	0.8	0.7	0.6	0.5	0.5	1.9	0.99	0.88
	4	9.3	8.1	57.3	25.7	49.8	26.2	7.4	5.3	3.6	2.4	2.2	1.5	1.5	1.0	1.0	0.8	0.8	0.6	0.6	0.5	1.9	0.99	0.86

Unidrive-M Model size 3 EMC Data Sheet

3.1.6 Compliance with EN61000-3-12

The applicable standard for input currents in the range 16 A to 75 A is EN61000-3-12.

The drives are capable of meeting the requirements of EN61000-3-12, Table: 4, with $R_{SCE} \geq 120$, when used with the reactors specified in Table 4 below.

Table 4 Harmonic Currents with Recommended Chokes to Achieve EN61000-3-12, with $R_{sce} \geq 120$

Model No.	Motor Power (kW)	RMS current (A)	Fund. current (A)	THD (%)	PWhd (%)	Harmonic order, magnitude as % of fundamental																AC line choke nom (mH)	DPF Cos Ø	Power Factor
						5	7	11	13	17	19	23	25	29	31	35	37	41	43	47	49			
Mxxx - 032 00050A	1.1	4.3	4.1	36.6	18.5	33.8	10.7	7.0	3.4	2.8	2.0	1.3	1.2	0.7	0.8	0.5	0.5	0.4	0.4	0.3	0.3	6	0.99	0.92
	0.75	3.8	3.6	38.8	19.7	35.7	12.1	7.3	3.4	3.1	2.0	1.5	1.3	0.8	0.8	0.5	0.5	0.4	0.4	0.3	0.3	6	0.99	0.92
Mxxx - 032 00066A	1.5	5.3	4.9	36.5	18.4	33.8	10.7	6.9	3.4	2.8	2.0	1.3	1.2	0.7	0.8	0.5	0.5	0.4	0.3	0.3	0.3	5	0.99	0.9
	1.1	5.0	4.7	37.2	18.9	34.4	11.1	7.0	3.4	2.9	2.0	1.4	1.3	0.8	0.8	0.5	0.5	0.4	0.4	0.3	0.3	5	0.99	0.91
Mxxx - 032 00080A	2.2	8.4	7.8	37.4	18.6	34.6	11.2	7.0	3.4	2.9	2.0	1.4	1.2	0.7	0.8	0.5	0.5	0.4	0.3	0.3	0.3	3	0.99	0.9
	1.5	6.2	5.7	43.3	21.8	39.3	15.2	7.6	3.7	3.4	2.0	1.8	1.4	1.0	0.9	0.7	0.6	0.4	0.5	0.4	0.3	3	0.99	0.9
Mxxx - 032 00106A	3	9.6	9.0	35.2	17.2	32.7	9.8	6.6	3.4	2.6	1.9	1.2	1.1	0.7	0.7	0.5	0.4	0.4	0.3	0.3	0.3	3	0.99	0.91
	2.2	8.1	7.6	38.0	19.1	35.1	11.5	7.1	3.4	2.9	2.0	1.4	1.3	0.8	0.8	0.6	0.5	0.4	0.4	0.3	0.3	3	0.99	0.91
Mxxx - 034 00025A	1.1	2.4	2.2	38.5	19.2	35.5	11.9	7.1	3.4	3.0	2.0	1.4	1.3	0.8	0.8	0.5	0.5	0.4	0.4	0.3	0.3	18	0.99	0.89
	0.75	1.8	1.6	44.4	21.9	40.2	16.0	7.7	3.8	3.4	2.0	1.8	1.3	1.1	0.9	0.7	0.6	0.4	0.5	0.3	0.3	18	0.99	0.86
Mxxx - 034 00031A	1.5	3.1	2.9	37.1	18.3	34.3	11.0	6.9	3.4	2.8	2.0	1.3	1.2	0.7	0.8	0.5	0.5	0.4	0.3	0.3	0.3	15	0.99	0.91
	1.1	2.2	2.0	43.9	21.7	39.9	15.7	7.6	3.7	3.4	2.0	1.8	1.3	1.0	0.9	0.7	0.6	0.4	0.5	0.3	0.3	15	0.99	0.88
Mxxx - 034 00045A	2.2	4.3	4.0	37.3	18.2	34.6	11.0	6.8	3.3	2.8	2.0	1.3	1.2	0.7	0.7	0.5	0.5	0.4	0.4	0.3	0.3	11	0.99	0.9
	1.5	3.2	2.9	43.2	21.0	39.3	15.1	7.4	3.6	3.3	1.9	1.7	1.3	1.0	0.9	0.6	0.6	0.4	0.4	0.3	0.3	11	0.99	0.88
Mxxx - 034 00062A	3	6.2	5.8	36.0	17.5	33.4	10.3	6.7	3.3	2.7	1.9	1.2	1.2	0.7	0.7	0.5	0.4	0.4	0.3	0.3	0.3	8	0.99	0.91
	2.2	5.1	4.7	39.5	19.7	36.4	12.5	7.2	3.4	3.0	2.0	1.5	1.3	0.8	0.8	0.6	0.5	0.4	0.4	0.3	0.3	8	0.99	0.89
Mxxx - 034 00078A	4	8.8	8.3	35.4	18.4	32.8	10.1	6.8	3.4	2.8	2.0	1.3	1.2	0.7	0.7	0.5	0.5	0.4	0.3	0.3	0.3	5	0.99	0.92
	3	6.7	6.3	40.0	21.2	36.6	13.1	7.3	3.5	3.3	2.0	1.7	1.4	0.9	0.9	0.6	0.6	0.4	0.4	0.3	0.3	5	0.99	0.92
Mxxx - 034 00100A	5.5	10.5	9.8	35.9	18.9	33.2	10.4	6.8	3.4	2.9	2.0	1.4	1.3	0.7	0.8	0.5	0.5	0.4	0.4	0.3	0.3	4	0.99	0.91
	4	8.6	8.0	39.2	20.9	35.9	12.6	7.2	3.5	3.2	2.0	1.6	1.4	0.9	0.9	0.6	0.6	0.4	0.4	0.3	0.3	4	0.99	0.91

Unidrive-M Model size 3 EMC Data Sheet

3.1.7 Line reactors

Suitable line reactors are available from Control Techniques. See Table 5.

Table 5 2% line reactors

Model No.	Maximum continuous Input Current (A)	Required line reactor inductance (mH)	Line reactor CT Part No.
Mxxx - 032 00050A	10.4	2.5	4401-0163
Mxxx - 032 00066A	12.6	2.5	4401-0163
Mxxx - 032 00080A	17.0	1.0	4401-0228
Mxxx - 032 00106A	20.0	1.0	4401-0228
Mxxx - 034 00025A	5.0	3.2	4401-0162
Mxxx - 034 00031A	7.0	3.2	4401-0162
Mxxx - 034 00045A	9.0	2.5	4401-0163
Mxxx - 034 00062A	13.0	2.5	4401-0163
Mxxx - 034 00078A	13.0	2.5	4401-0163
Mxxx - 034 00100A	16.0	1.9	4401-0164

3.1.8 Further measures for reducing harmonics

In most installations, harmonics do not cause problems unless more than 50% of the supply system capacity is consumed by the motor drive.

In such cases remedial measures such as harmonic filters may be used, installed at the common supply point. Harmonic currents from drives add approximately arithmetically.

Unidrive-M Model size 3 EMC Data Sheet

3.2 Conducted Radio Frequency Emission

3.2.1 Environment

Radio frequency emission in the range from 150 kHz to 30 MHz is generated by the switching action of the main power devices. It is mainly conducted out of the equipment through the electrical power wiring.

The drives are designed to comply with the product standard EN61800-3, Adjustable Speed Power Drive Systems - EMC requirements and specific test methods.

The standard defines two types of environment:

- First environment. Domestic premises and other premises that share a connection with domestic premises. Examples include houses, apartments, shops, offices in a residential building.
- Second environment. Factories and other premises that are supplied from a dedicated transformer.

3.2.2 EMC Category

The product standard defines four categories of product:

- Category C1 - intended for use in the first environment
- Category C2 - intended for use in the first environment, only when it is neither a plug-in device nor a movable device, and is intended to be installed and commissioned only by a professional
- Category C3 - intended for use in the second environment:
- Category C4 - intended for use in the second environment in a system rated at over 400 A, or in a complex system

Several factors affect the emissions including the type of motor cable, cable length, switching frequency and filtering. These are described in more detail below.

3.2.3 Choice of Motor Cable

In order to comply with the emission standards, screened (armoured) motor cable must be used.

Most types of cable can be used provided that it has an overall screen, which is continuous for its entire length. SY cable to BS EN 50525 is recommended. Armoured steel cable is acceptable.

The capacitance of the cable forms a load on the drive and filter, and should be kept to a minimum.

3.2.4 Cable length

The level of conducted emissions is affected by the length of the cable. The shorter the cable is, the lower the emissions. The maximum motor cable length may be extended up to 20 m by the use of a ferrite ring at the output.

3.2.5 Switching Frequency

The level of conducted emission is affected by the drive switching frequency. The lower the switching frequency is, the lower the emissions.

3.2.6 Internal Filter

The drives contain an internal filter which is sufficient to provide compliance with EN 61800-3 to Category C3 or C4, up to a maximum motor cable length of 2 m for 200 V drives and up to 5 m for 400 V drives.

The internal filter is the most economic option for industrial installations. For practical purposes, this filter in conjunction with a screened motor cable is sufficient to prevent the drive from causing interference to most good-quality industrial equipment.

Unidrive-M Model size 3 EMC Data Sheet

3.2.7 Earth leakage current

The internal filter has an earth leakage current of up to 28 mA. In some installations this is not acceptable. The User Guide gives instructions on how to remove and replace the internal filter.

3.2.8 External filter

If the drive is required to comply with category C1 or C2, then an external filter must be used.

Table 6 Recommended external filters

Model No.	Filter CT Part No.	
	Schaffner	Fuss
All 200V rated models	4200-2007	4200-3230
All 400V rated models	4200-1607	4200-3480

If the drive is used in the first environment with category C1 or C2 provisions according to EN 61800-3, the drive may cause radio interference requiring supplementary mitigation measures.



WARNING

The external filters and the internal filter have earth leakage current exceeding 3.5 mA. A permanent fixed earth connection is necessary to avoid electrical shock hazard. Further precautions, such as a supplementary earth connection or earth monitoring system, may also be required.

The tables below summarise the filtering options and the effect on compliance with the emissions standards.

Table 7 All 200 V rated models

Motor cable length (m)	Switching Frequency (kHz)					
	2	4	6	8	12	16
Using internal filter:						
0 – 2	C3	C3	C4	C4	C4	C4
Using internal filter and ferrite ring (1 turn):						
0 – 10	C3	C3	C3	C4	C4	C4
10 – 20	C3	C3	C4	C4	C4	C4
Using external filter:						
0 – 20	R	I	I	I	I	I
20 - 100	I	-	-	-	-	-

Table 8 All 400 V rated models

Motor cable length (m)	Switching Frequency (kHz)					
	2	4	6	8	12	16
Using internal filter:						
0 – 5	C3	C3	C4	C4	C4	C4
Using internal filter and ferrite ring (2 turns):						
0 – 10	C3	C3	C3	C3	C4	C4
Using external filter:						
0 – 20	R	I	I	I	I	I
20 - 100	I	-	-	-	-	-

The requirements are listed in descending order of severity, so that if a particular requirement is met then all requirements listed after it are also met.

Unidrive-M Model size 3 EMC Data Sheet

Table 9 Conducted Emissions Limits and Key to Tables 7 and 8

Code	Standard	Description	Frequency range	Limits	Application
R	EN 61000-6-3 IEC 61000-6-3 EN 50081-1	Residential: Generic emission standard for the residential commercial and light - industrial environment	0.15 - 0.5 MHz limits decrease linearly with log frequency	66-56 dB μ V quasi peak 56-46 dB μ V average	AC supply lines
			0.5 - 5 MHz	56 dB μ V quasi peak 46 dB μ V average	
			5 - 30 MHz	60 dB μ V quasi peak 50 dB μ V average	
	EN 61800-3 IEC 61800-3	Product standard for adjustable speed power drive systems	Category C1		
I	EN 61000-6-4 IEC 61000-6-4 EN 50081-2	Industrial: Generic emission standard for the industrial environment	0.15 – 0.5 MHz	79 dB μ V quasi peak 66 dB μ V average	AC supply lines
			0.5 –30 MHz	73 dB μ V quasi peak 60 dB μ V average	
	EN 61800-3 IEC 61800-3	Product standard for adjustable speed power drive systems	Category C2		
C1	EN 61800-3 IEC 61800-3	Product standard for adjustable speed power drive systems	Category C1 - intended for use in the first environment		
C2			Category C2 - intended for use in the first environment, only when it is neither a plug-in device nor a movable device, and in intended to be installed and commissioned only by a professional		
C3			Category C3 - intended for use in the second environment:		
C4			Category C4 - intended for use in the second environment in a system rated at over 400A, or in a complex system		

Notes

1. Where the drive is incorporated into a system with rated input current exceeding 400 A, the higher emission limits of EN 61800-3 for the second environment are applicable, and no filter is required.

2. Operation without a filter is a practical cost-effective possibility in an industrial installation where existing levels of electrical noise are likely to be high, and any electronic equipment in operation has been designed for such an environment. This is in accordance with EN 61800-3 category C4. There is some risk of disturbance to other equipment, and in this case the user and supplier of the drive system must jointly take responsibility for correcting any problem which occurs.

3.2.9 Related product standards

The conducted emission levels specified in the generic emission standards are equivalent to the levels required by the following product specific standards:

Unidrive-M Model size 3 EMC Data Sheet

Table 10 Conducted Emissions Standards, 150 kHz to 30 MHz

Generic standard	Product standard	
EN 61000-6-3 EN 50081-1	EN 55011 Class B CISPR 11 Class B	Industrial, scientific and medical equipment
	EN 55014 CISPR 14	Household electrical appliances
	EN 55022 Class B CISPR 22 Class B	Information technology equipment
EN 61000-6-4 EN 50081-2	EN 55011 Class A Group 1 CISPR 11 Class A Group 1	Industrial, scientific and medical equipment
	EN 55022 Class A CISPR 22 Class A	Information technology equipment

3.2.10 Ferrite ring information

The ferrite ring referred to above is Epcos part number B64290 L0048 X 830

3.2.11 Shared external filters for multiple drives

When more than one drive is used in the same enclosure, some cost saving is possible by sharing a single filter of suitable current rating between several drives. Tests have shown that combinations of drives with a single filter are able to meet the same emission standard as a single drive, provided that all filters and drives are mounted on the same metal plate. Because of the unpredictable effect of the additional wiring and the need for separate fuses for the drives on the drive side of the filter, this arrangement is not recommended where strict compliance with a specific standard is required, unless emission tests can be carried out.

3.2.12 Typical conducted emission test data

The conducted emission from one of the drives is shown in Figure 3.

The operating conditions are:

- Recommended external filter
- Switching frequency = 3 kHz
- Motor cable length = 100 m

Unidrive-M Model size 3 EMC Data Sheet

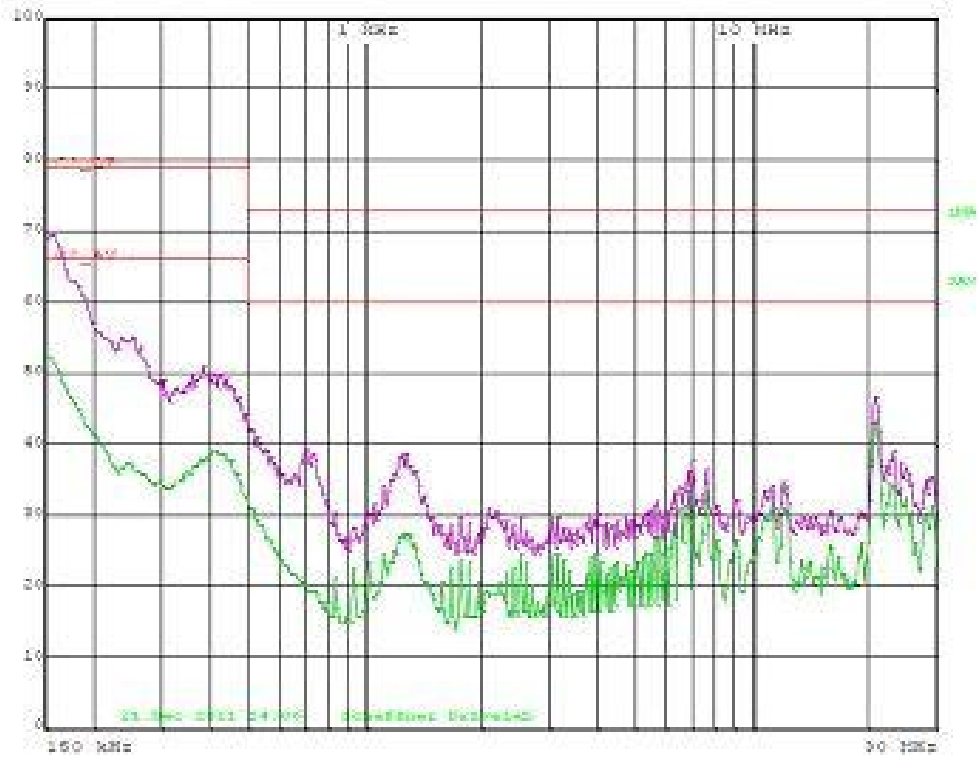

Figure 3 Conducted Emission M700- 034 00100A, 3 kHz switching frequency, 100 m cable.

Unidrive-M Model size 3 EMC Data Sheet

3.3 Radiated Emission

3.3.1 Compliance

When installed in a standard metal enclosure according to the wiring guidelines, the drive will meet the radiated emission limits required by the generic industrial emission standard EN 61000-6-4 (previously EN 50081-2).

The limits for emission required by the generic emission standards are summarised in the following table:

Table 11 Generic Radiated Emissions Limits

Standard	Frequency range	Limits	Category	Comments
EN 61000-6-3	30 - 230 MHz	30 dB μ V/m quasi peak at 10 m	C1	
	230 - 1000 MHz	37 dB μ V/m quasi peak at 10 m		
EN 61000-6-4	30 - 230 MHz	40 dB μ V/m quasi peak at 10 m	C2	Standard specifies limits of 30 and 37 dB μ V/m respectively at a measuring distance of 30 m; emission may be measured at 10 m if limits are increased by 10 dB
	230 - 1000 MHz	47 dB μ V/m quasi peak at 10 m		
EN61800-3	30 - 230 MHz	50 dB μ V/m quasi peak at 10 m	C3	
	230 - 1000 MHz	60 dB μ V/m quasi peak at 10 m		

3.3.2 Related product standards

The radiated emission levels specified in EN 61000-6-4 are equivalent to the levels required by the following product standards:

Table 12 Radiated Emission Standards (30 MHz - 1000 MHz)

Generic standard	Product standard	
EN 61000-6-4	CISPR 11 Class A Group 1 EN 55011 Class A Group 1	Industrial, scientific and medical equipment
	EN 55022 Class A CISPR 22 Class A	Information technology equipment
	EN 61800-3	Adjustable speed electrical power drive systems

Unidrive-M Model size 3 EMC Data Sheet

3.3.3 Test Conditions

Tests were carried out with the drive installed in a representative enclosure, following the guidelines given in this data sheet. No special EMC techniques were used beyond those described here. Every effort was made to ensure that the arrangements were robust enough to be effective despite the normal variations which will occur in practical installations. However no warranty is given that installations built according to these guidelines will necessarily meet the same emission limits.

3.3.4 Enclosure construction

Most enclosures have a back-plate which is used to mount variable speed drive modules, RFI filters and ancillary equipment. This back-plate can be used as the EMC earth plane, so that all metal parts of these items and cable screens are fixed directly to it. Its surface should have a conductive protective surface treatment such as zinc plate. If it is painted then paint will have to be removed at the points of contact to ensure a low-inductance earth connection which is effective at high frequency.

The motor cable screen must be clamped to the drive grounding clamp. It may also be bonded at the point of exit, through the normal gland fixings.

Depending on construction, the enclosure wall used for cable entry might have separate panels and have a poor connection with the remaining structure at high frequencies. If the motor cable is only bonded to these surfaces and not to a back-plate, then the enclosure may provide insufficient attenuation of RF emission. The use of the purpose-designed drive grounding clamp is strongly recommended.

It is the bonding to a common metal plate which minimises radiated emission. There is no need for a special EMC enclosure with gaskets etc. In the tests described, opening the cubicle door had little effect on the emission level, showing that the enclosure itself does not provide significant screening

The test data are based on radiated emission measurements made in a standard steel enclosure containing a single drive, in a calibrated open area test site. Details of the test arrangement are as follows:

A standard Rittal steel enclosure was used having dimensions 1900 mm (high) × 600 mm (wide) × 500 mm (deep). Two ventilation grilles, both 200 mm square, were provided on the upper and lower faces of the door. No special EMC features were incorporated.

The drive and recommended RFI input filter were fitted to the internal back-plate of the enclosure, the filter casing making electrical contact with the back-plate by the fixing screws. Standard unscreened power cable was used to connect the cubicle to the supply.

An appropriately rated, standard AC induction motor was connected by 2 m of shielded cable (steel braided - type SY) and mounted externally. In order to allow for realistic imperfections in the installation, the motor cable was interrupted by a DIN rail terminal block mounted in the enclosure. The shield pigtailed (50 mm long) were connected to the back plate through an earthed DIN rail terminal block. The motor screen was not bonded to the enclosure wall at the point of entry.

A 2 m screened control cable was connected to the drive control terminals, but the screen was isolated from the cubicle wall.

The RS485 communication module fitted in the control pod has its cables' shielding braids bonded to the grounding bracket (see Figure 9).

The drive was operated at 6 Hz, with a switching frequency of 16 kHz which is the worst case for RF emission. No additional EMC preventative measures were taken, e.g. RFI gaskets around the cubicle doors.

Unidrive-M Model size 3 EMC Data Sheet

3.3.5 Test Data

The table below summarises the results for radiated emission, showing the highest measurements over the frequency range 30 to 1000 MHz:

Table 13 Radiated Emission Measured Levels M700 - 034 00100A

Frequency (MHz)	Emission (dB μV/m)	Level required by EN 61000-6-4 C2 at 10 m (dB μV/m)
30.0	31.16	40
30.36	30.97	40
30.72	30.56	40
32.24	34.12	40
53.44	32.66	40
57.2	28.71	40

Note.1: The Standard specifies limits of 30 and 37 dB μ V/m respectively at a measuring distance of 30 m. Emission may be measured at 10 m if limits are increased by 10 dB

Conclusion: The limit for EN 61000-6-4 C2 is met with a margin of at least 5 dB.

Unidrive-M Model size 3 EMC Data Sheet

4. Installation and Wiring Guidelines

4.1.1 General Guidelines

The wiring guidelines on the following pages should be observed to achieve minimum radio frequency emission. The details of individual installations may vary, but aspects which are indicated in the guidelines as important for EMC must be adhered to closely.

The guidelines do not preclude the application of more extensive measures which may be preferred by some installers. For example, the use of full 360° ground terminations on shielded cables in the place of 'pig-tail' ground connections is beneficial, but is not necessary unless specifically stated in the instructions.

4.1.2 Mounting on back plate

If the filter is not used in the "footprint" mode, then the drive and filter must be mounted on the same metal back-plate, and their mounting surfaces must make a good direct electrical connection to it. The use of a plain metal back-plate (e.g. galvanised not painted) is beneficial for ensuring this without having to scrape off paint and other insulating finishes.

The filter must be mounted close to the drive so that its connecting wires can be directly connected. The wires must not be extended.

A shielded (screened) or steel wire armoured cable must be used to connect the drive to motor. The shield must be bonded to the drive using the grounding clamp provided.

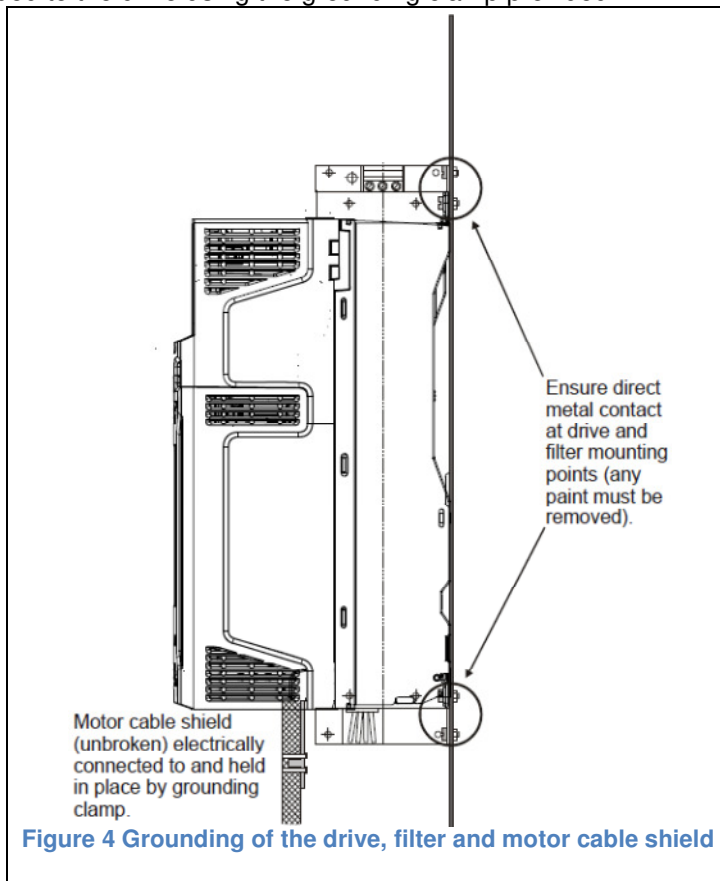

4.1.3 Separation of AC supply connections

The AC supply connections must be kept at least 100 mm (4 inches) from the drive, motor cable and braking resistor cable.

Unidrive-M Model size 3 EMC Data Sheet

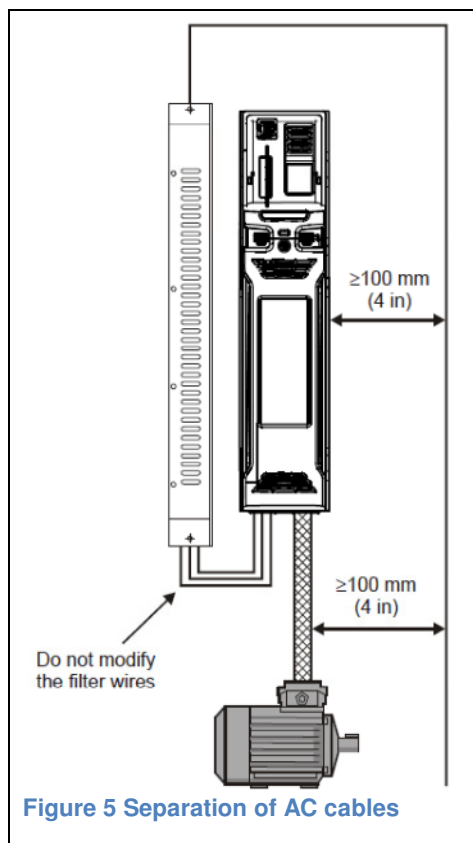

4.1.4 Connection of motor cable shield at the motor

Connect the shield of the motor cable to the ground terminal of the motor frame using a link that is as short as possible and not exceeding 50 mm (2 inches) in length. A full 360° termination of the shield to the motor terminal housing (if metal) is beneficial.

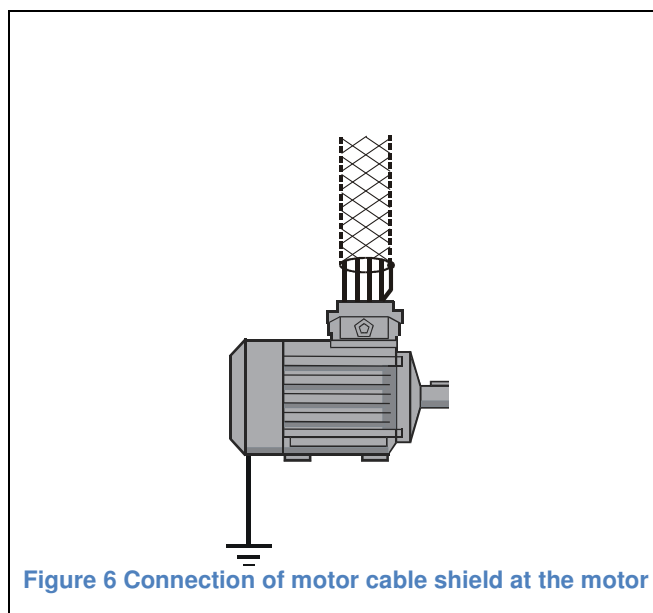

4.1.5 Use of additional safety earth wire

If an additional safety earth wire is required for the motor, it can either be carried inside or outside the motor cable shield. If it is carried inside then it must be terminated at both ends as close as possible to

Unidrive-M Model size 3 EMC Data Sheet

the point where the screen is terminated. It must always return to the drive and not to any other earth circuit.

4.1.6 Braking resistor wiring

Wiring to the braking resistor should be shielded. The shield must be bonded to the back-plate using an un-insulated metal cable-clamp. It need only be connected at the drive end.

If the braking resistor is outside the enclosure then it should be surrounded by an earthed metal shield.

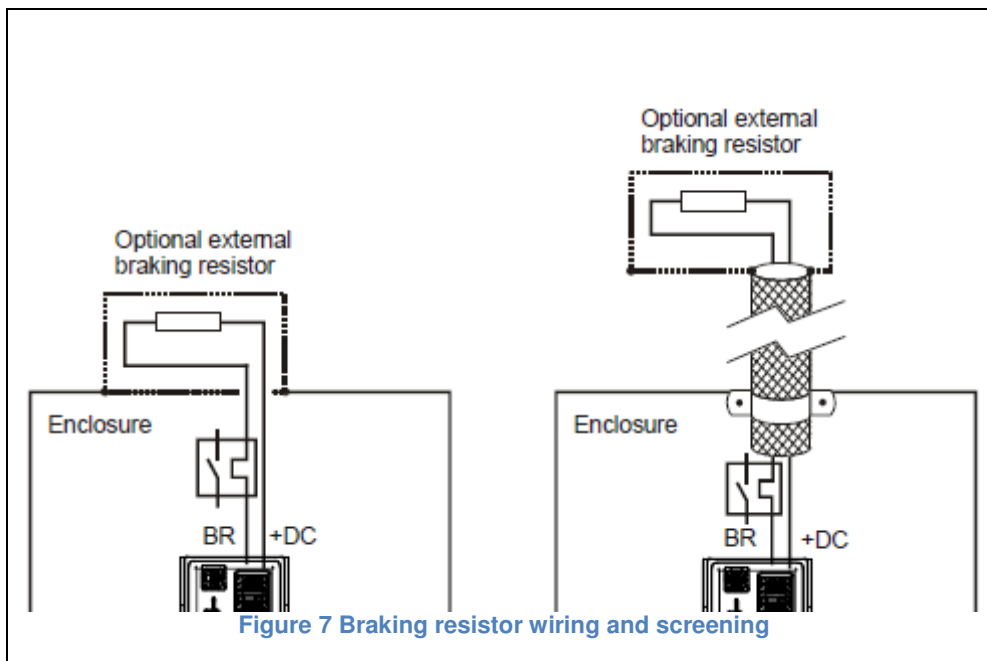

4.1.7 Signal and control wiring

Signal and control wiring must be kept at least 300 mm (12 inches) from the drive and motor cable.

Unidrive-M Model size 3 EMC Data Sheet

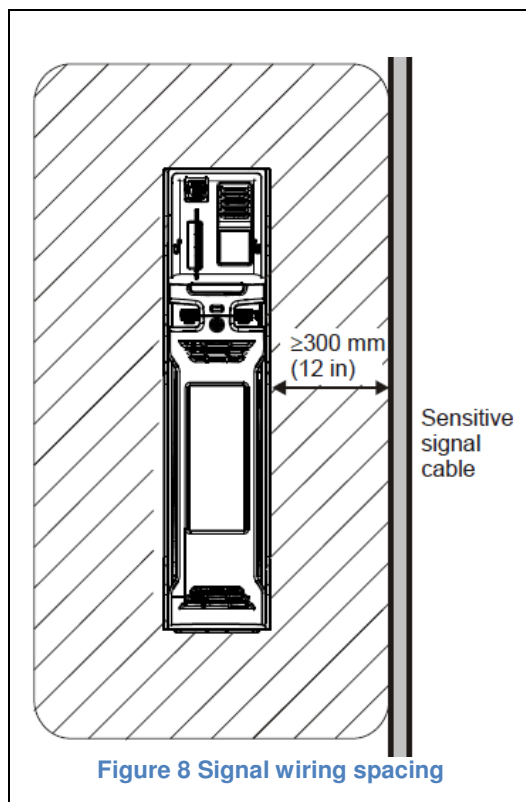

The control wiring “0 V” connection should be earthed at one point only, preferably at the controller and not at a drive.

4.1.8 Ferrite ring

If the ferrite ring is to be used to further reduce conducted emission, it should be mounted close to the drive, and the output power conductors (U, V, W but not E) should be passed twice through the central aperture, all together in the same direction.

4.1.9 Wiring routed outside the enclosure

If drive control wiring leaves the enclosure then one of the following additional measures must be taken: (This includes all control, encoder and option module wiring but not the status relay circuit or the serial port).

1. Use shielded cables (one overall shield or separate shielded cables) and clamp the shield(s) to the grounding bracket provided.
2. Pass the control wires through a ferrite ring part number 3225-1004. More than one cable can pass through a ring. Ensure the length of cable between the ring and drive does not exceed 125 mm (5 inches).

Unidrive-M Model size 3 EMC Data Sheet

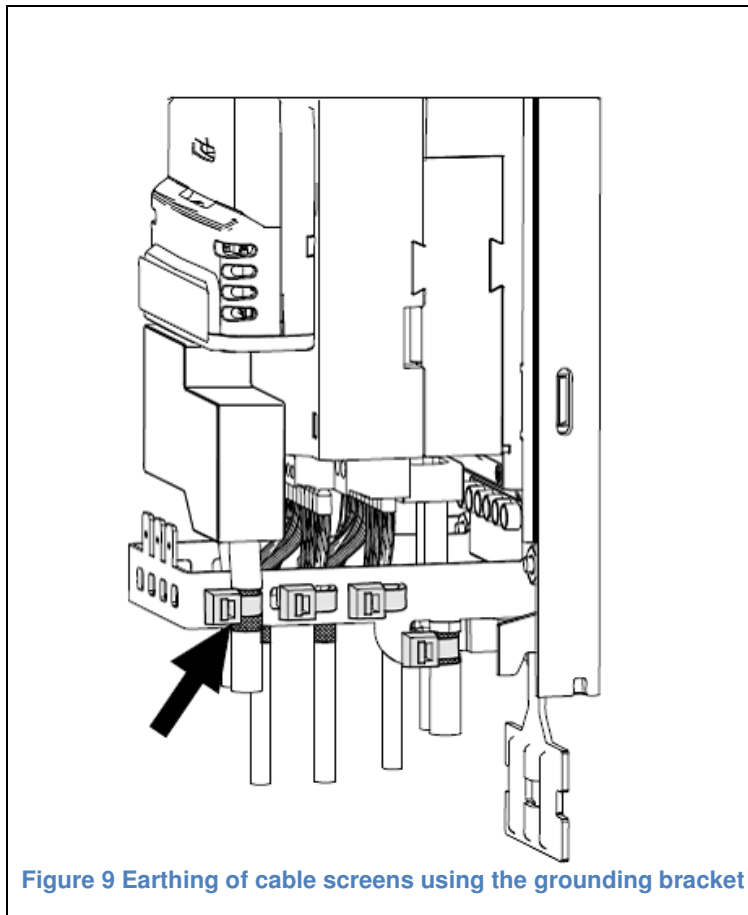

4.1.10 Interruptions to the motor cable

The motor cable should ideally be a single run of shielded cable having no interruptions. In some situations it may be necessary to interrupt the cable, for example to connect the motor cable to a terminal block within the drive enclosure, or to fit an isolator switch to allow safe working on the motor. In these cases the following guidelines should be observed. The most important factor is always to minimise the inductance of the connection between the cable shields.

4.1.11 Terminal block within enclosure

The motor cable shields should be bonded to the back-plate using un-insulated cable-clamps which should be positioned as close as possible to the terminal block. Keep the length of power conductors to a minimum and ensure that all sensitive equipment and circuits are at least 0.3 m (12 inches) away from the terminal block.

Unidrive-M Model size 3 EMC Data Sheet

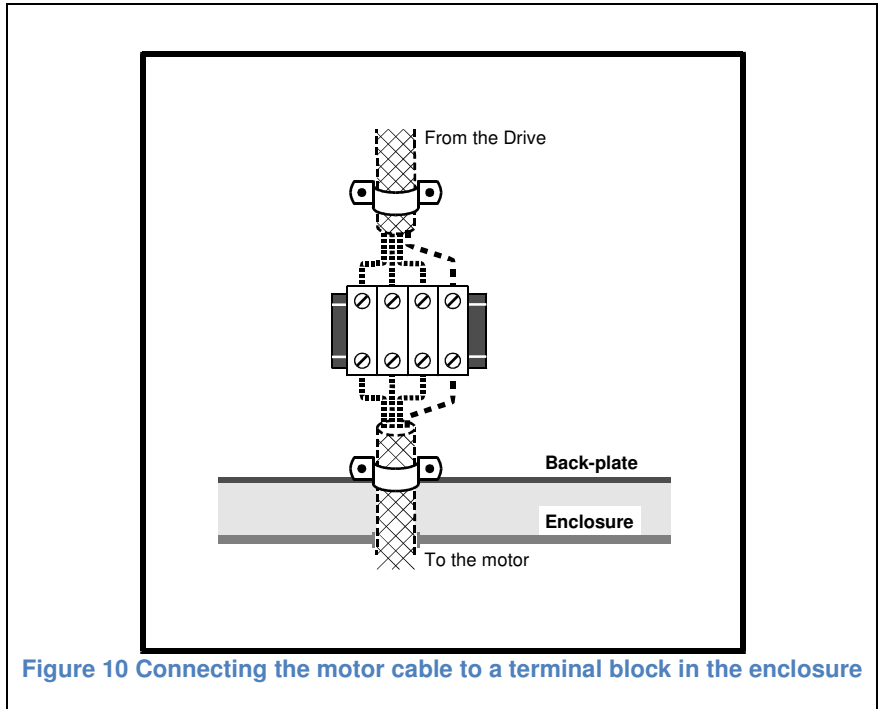

Figure 10 Connecting the motor cable to a terminal block in the enclosure

4.1.12 Using a motor isolator switch

The motor cable shields should be connected by a very short conductor having a low inductance. The use of a flat metal bar is recommended; conventional wire is not suitable. The shields should be bonded directly to the coupling bar using un-insulated metal cable-clamps. Keep the length of power conductors to a minimum and ensure that all sensitive equipment and circuits are separated by at least 0.3 m (12 inches). The coupling bar may be grounded to a known low impedance ground nearby, for example a large metallic structure which is connected closely to the drive ground.

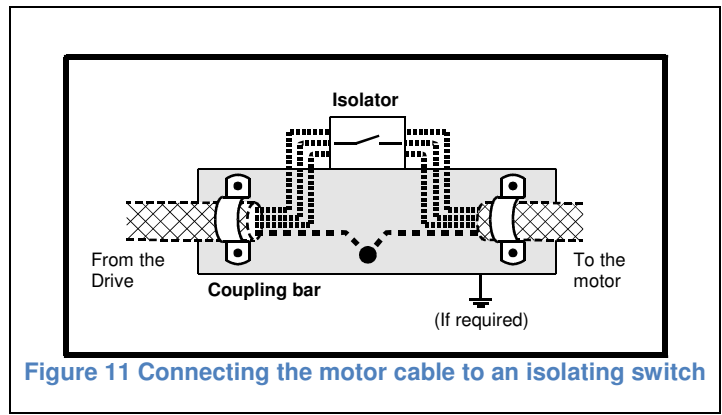

Figure 11 Connecting the motor cable to an isolating switch